

Quarz Specials

RONDA startech 5000

Caliber 5020.B – 12½"



Product Specifications

Analog quartz movement

Line	startech
Caliber	5020.B
Size	12½"
Version Swiss Made	10 Jewels / gold plated
Version Swiss Parts	5 Jewels / nickel plated
Standard battery life	54 months
Hand fitting height	2

Features

- Very long battery life
- Repairable metal watch movement
- Power saving mechanism with pulled out stem: Reduction of consumption approximately 70%
- Very easy handling by two pushers

Functions

- Chronograph
- Center stop second (1/1 sec)
- 30 minute / 12 hour counter
- ADD and SPLIT functions
- 2 eyes
- Big date
- Small second

Quarz Specials

RONDA startech 5000

Caliber 5020.B – 12½"

Technical Specifications

Diameter Total	28.60 mm
Case fitting	28.00 mm
Movement height	4.40 mm
Height over standard battery	4.40 mm
Movement rest	0.60 mm
Height over stem	1.90 mm
Length of stem travel	0.90 mm
Stem thread	0.90 mm
Standard battery	395
Standard battery life	54 months
Battery voltage	1.5 V
Current consumption – typical	1.32 µA (Date Mechanism not in Gear)
Current consumption – maximum	1.65 µA (Date Mechanism not in Gear)
Useful torque second – typical	6 µNm
Useful torque minute – typical	300 µNm
Useful torque center stop second – typical	7 µNm
Operating temperature	0 - 50 °C
Instantaneous rate	-10/ +20 sec/month
Resistance to magnetic fields	18.8 Oe
Resistance against shock	NIHS 91-10



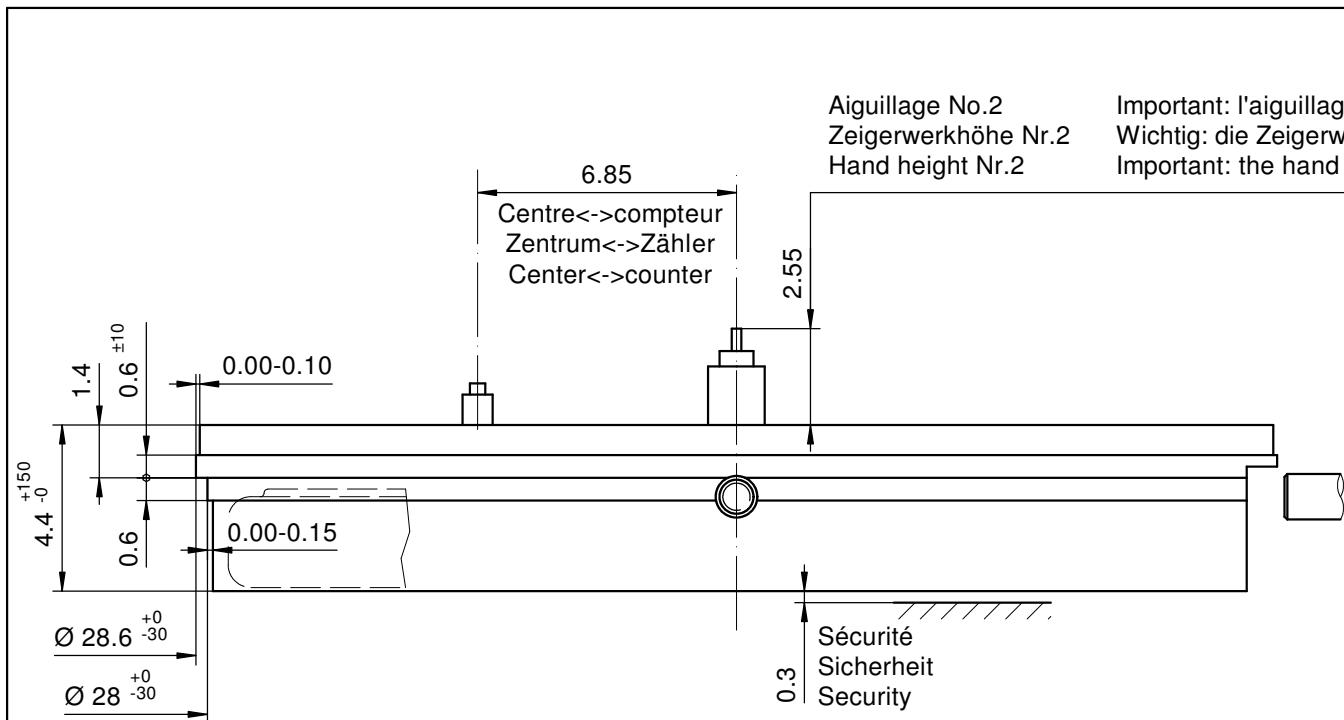

Aiguillage No.2
Zeigerwerkhöhe Nr.2
Hand height Nr.2

Important: l'aiguillage peut varier selon le modèle
Wichtig: die Zeigerwerkhöhe kann bei verschiedenen Modellen unterschiedlich sein
Important: the hand height can vary between different models

Sécurité entre l'aiguille des secondes et le verre: 0.30mm
Sicherheit zwischen Sekundenzeiger und Glas: 0.30mm
Security between second hand and glass:

Le cadran doit être tenu par la boîte
Das Zifferblatt muss durch die Schale gehalten werden
The dial must be hold by the case

La course du poussoir doit être limitée dans le poussoir lui-même. Sa position poussée doit être contrôlée.

Die Weglänge des Drückers ist im Drücker selbst zu begrenzen. In der gedrückten Stellung ist seine Position zu kontrollieren

The way of the pusher has to be limited in the pusher itself. Its position must be checked while pushed in.

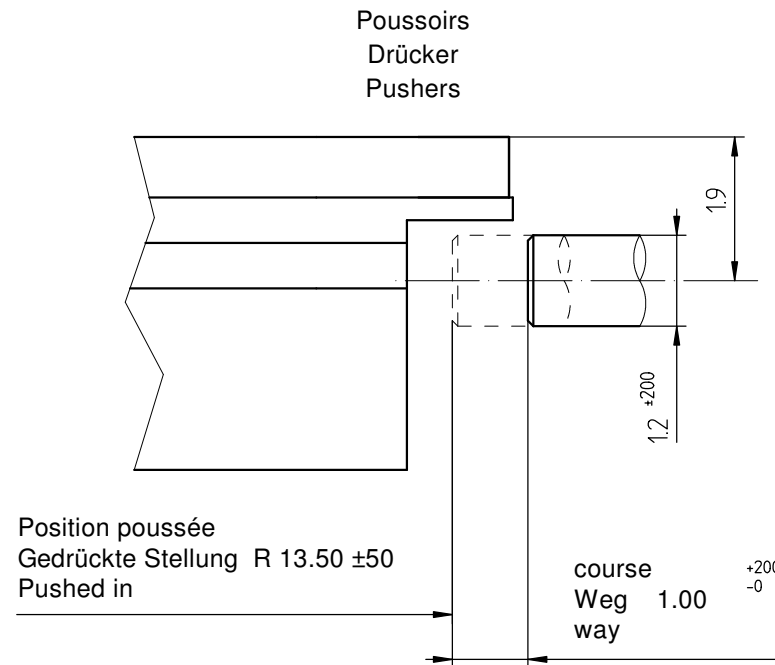

Côté fond de boîte
Seite Gehäuseboden
Case back side
Position pour extraire la tige
Position zum Entfernen der Stellwelle
Position to remove the stem

Pile Batterie (395) Ø 9.50 x 2.60mm
Battery

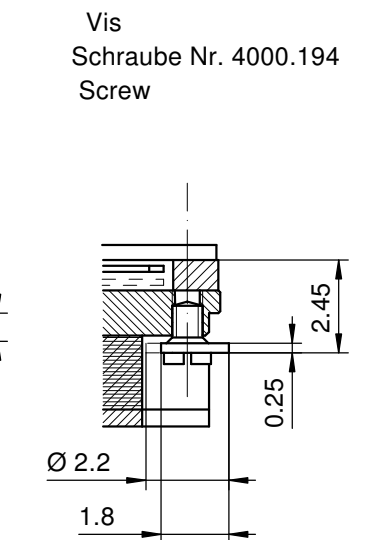
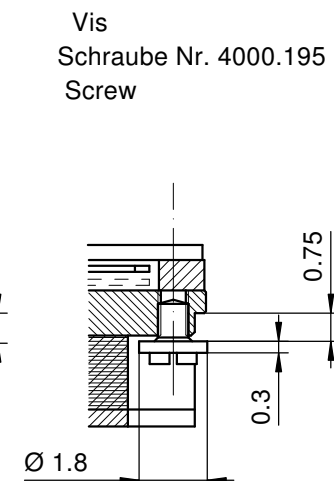
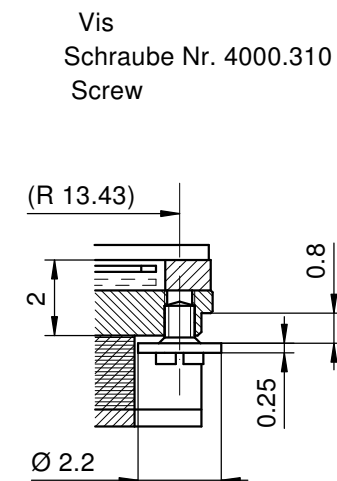
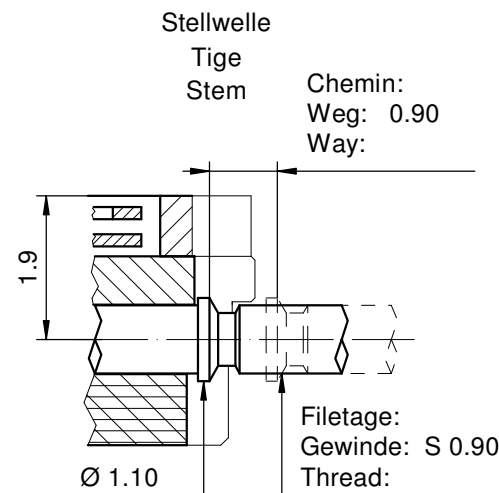
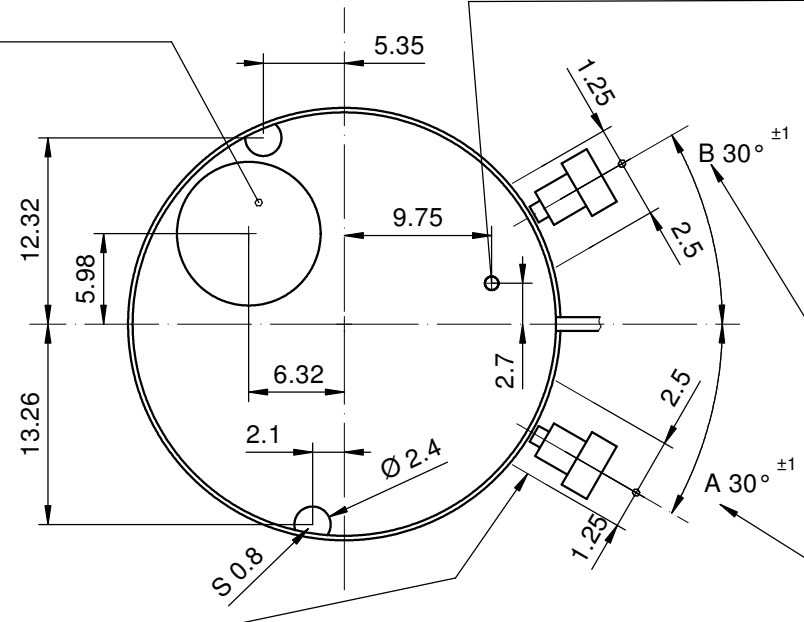

Dégagement cercle d'entourage pour poussoir
Freistellung Gehäuseering für Drücker
Opening movement holder for pusher

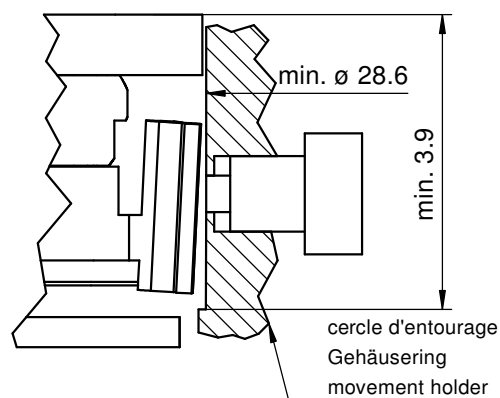

L'angle indiqué pour la direction du poussoir et la position doivent être respectés.
Pour un angle de 0° des poussoirs A et B, voir plan 5000.345

Der angegebene Winkel für die Drückerrichtung und die Position müssen eingehalten werden.
Für einen Drückerwinkel von 0° bei A und B, siehe Zeichnung 5000.345

The indicated angle of the pusher direction and the position must be fulfilled. For pusher angles of 0° (pusher A and B), see drawing 5000.345.

Cage
Uhrwerkgestell 12½"
Frame

RONDA 5020.B

Issued	14 Nov 2003	mk
Modified	05 Sep 2016 ÅA 34777	dh
Released	YES	
Tolerance	+/- 20 µm	
Scale	10 : 1 (5 : 1) (A3H)	
Sous réserve de modifications Änderungen vorbehalten Modifications reserved		
No.	5000.321	03

Angle Winkel Angle	30°	
Ø Dp	b	
1.00	13.50	
1.10	13.50	
1.20	13.50	
1.30	13.50	
1.40	13.50	

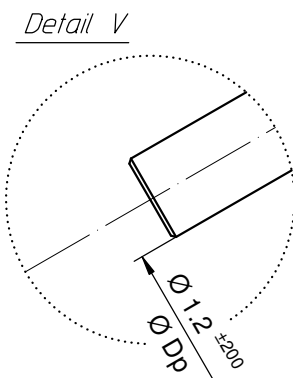
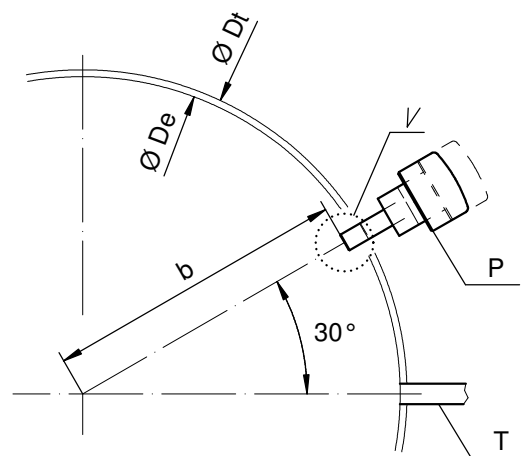

Angle Winkel Angle	0°	
Ø Dp	a	b
1.30	7.40	11.43
1.40	7.45	11.40

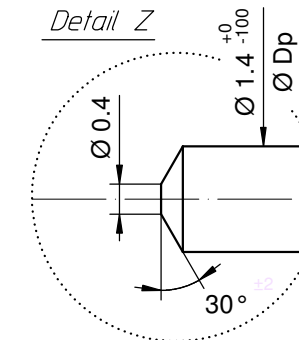
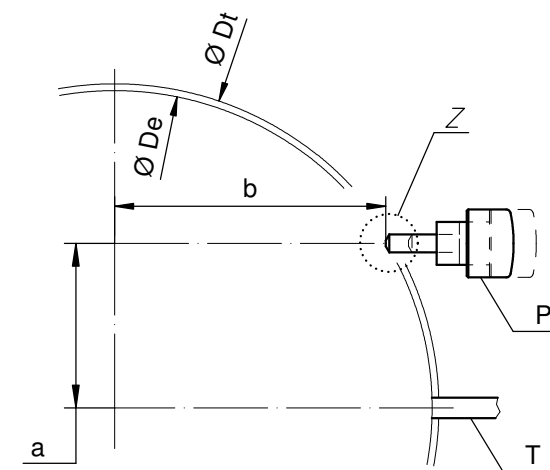

Angle Winkel Angle	20°	
Ø Dp	a	b
1.30	2.57	13.22
1.40	2.59	13.21

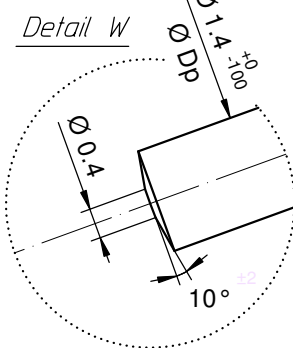
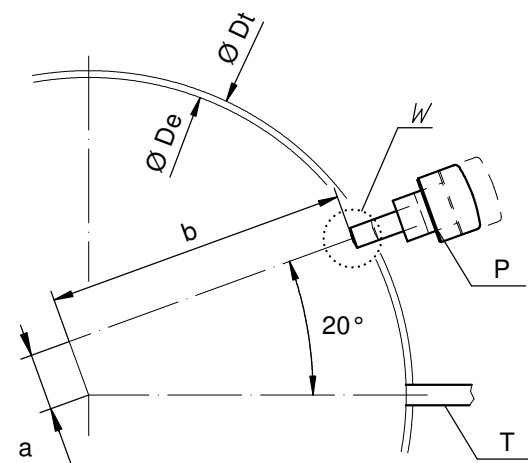

Ø De: diamètre d'encageage
Durchmesser der Gehäusepassung
fitting-diameter

Ø Dp: diamètre du poussoir
Drückerdurchmesser
pusher-diameter

Ø Dt: diamètre total
Totaldurchmesser
total-diameter

P: poussoir en position poussée
Drücker in gedrückter Stellung
pusher in pressed position

T: tige de mise à l'heure
Stellwelle
stem

Angle Winkel Angle	15°	
Ø Dp	a	b
1.30	3.83	12.92
1.40	3.86	12.91

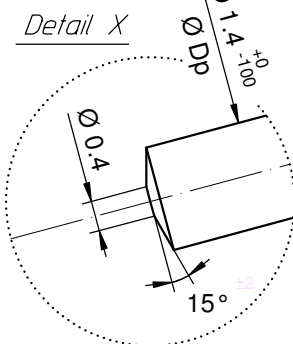
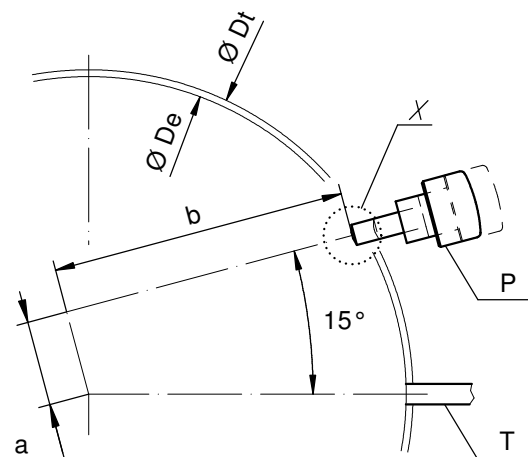

Angle Winkel Angle	10°	
Ø Dp	a	b
1.30	5.06	12.52
1.40	5.10	12.50

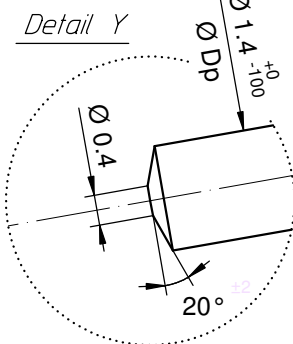
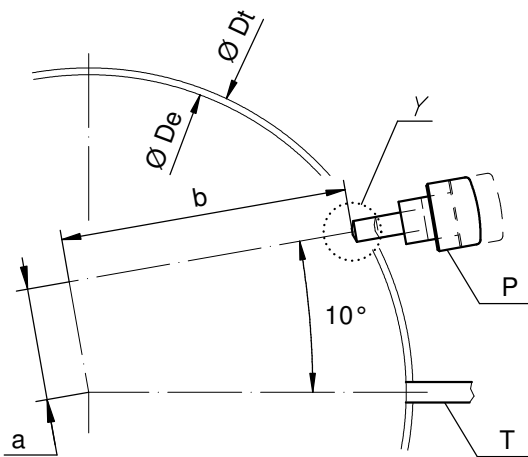

Angle des poussoirs A et B
Winkel der Drücker A und B
Angle of pusher A and B

RONDA 4xxx.x, 5xxx.x

Issued	06 Sep 2004	mk
Modified	30.März 2005 ÄA 1784	mk
Released	YES	
Tolerance	+/- 20 µm	
Scale	10 : 1 (5 : 1) (A3H)	
Sous réserve de modifications Änderungen vorbehalten Modifications reserved		
No.	5000.345	01

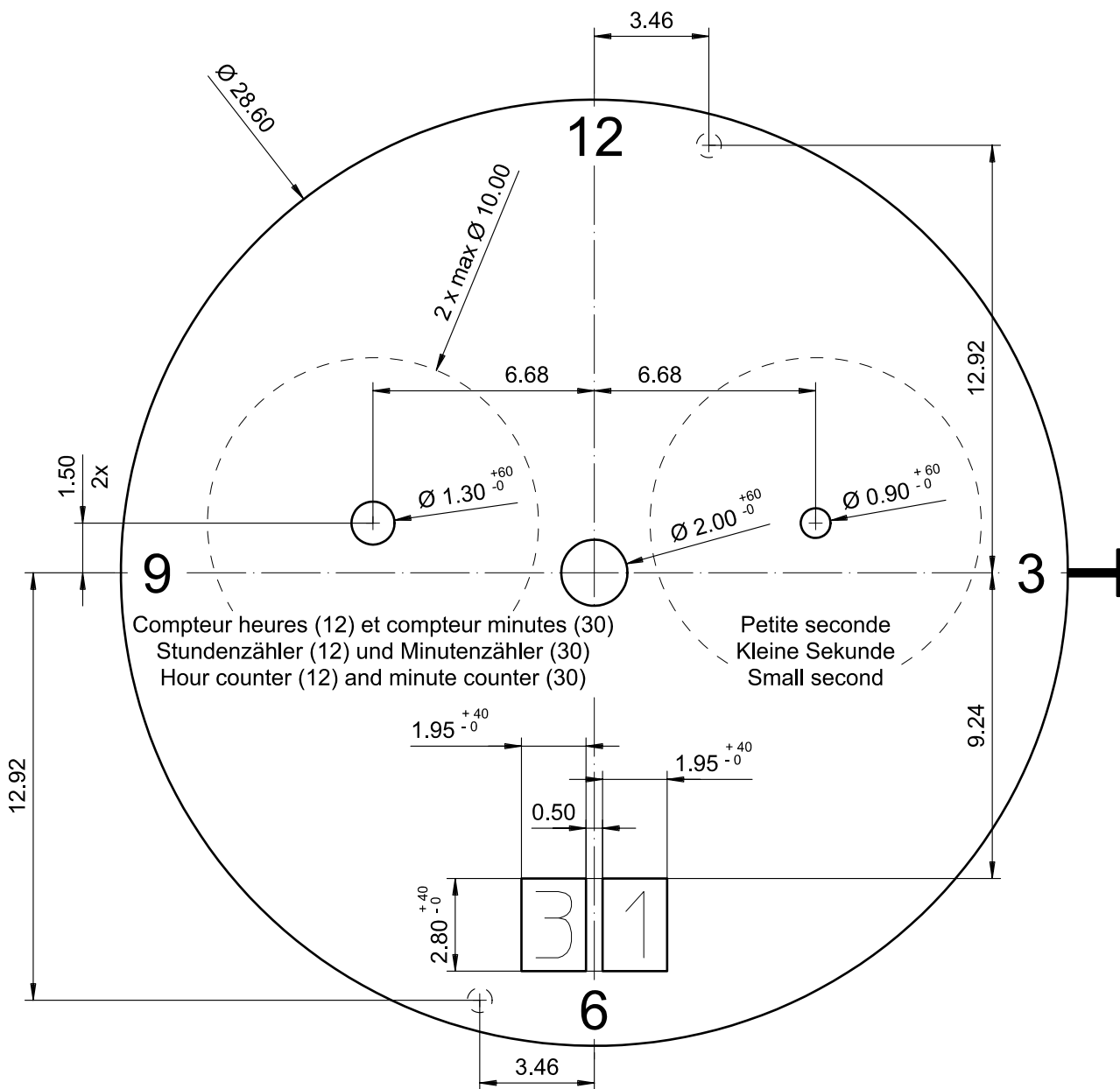

Compteur heures (12) et compteur minutes (30)
 Stundenzähler (12) und Minutzähler (30)
 Hour counter (12) and minute counter (30)

Petite seconde
 Kleine Sekunde
 Small second

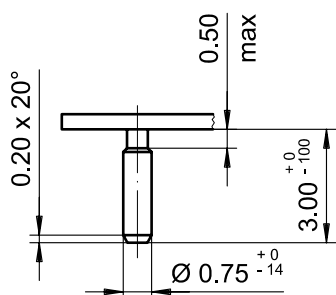

Epaisseur du cadran selon hauteur de l'aiguillage
 Zifferblattdicke gemäss Zeigerwerkhöhen
 Dial thickness according to hand fitting heights

Tige	Date
Stellw.	Datum
Stem	Date
3H	6H

Cadran
 Zifferblatt
 Dial

12'''

Issued	13 Dez 2006	cw
Modified	13 Dez 2006 ÄA ----	cm
Released	YES	
Tolerance	+/- 20 µm	
Scale	5 : 1 (A4V)	

RONDA

5020.B

Sous réserve de modifications
 Aenderungen vorbehalten
 Modifications reserved

No. 5010.691 03

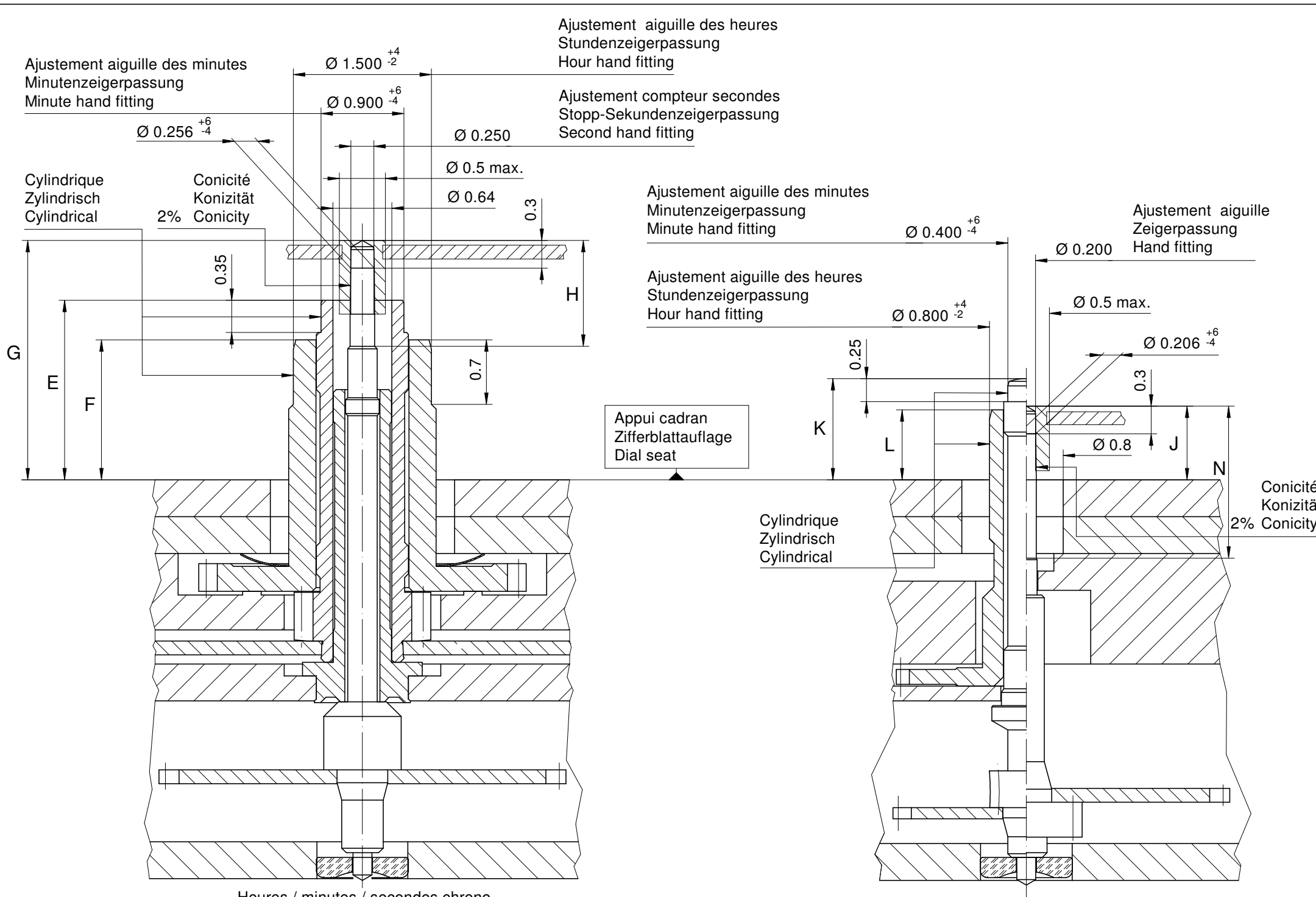

Aiguillages Zeigerwerkhöhe Hand fitting height								
Dépassement Höhe über Zifferblattauflage Height over dial seat								
No	G	E	F	H	N	Compteur 2 aig. 2 Zeiger Zähler 2 Hand counter		J
						K	L	
2	2.60	1.95	1.52	1.15	1.65	1.10	0.76	0.80
-								

Heures / minutes / secondes chrono
Stunden / Minuten / Stopp-Sekunden
Hours / minutes / chrono second

Compteur 2 aiguille
2 Zeiger Zähler
2 Hand counter
Petite seconde
Kleine Sekunde
Small second

Aiguillages Zeigerwerkhöhe Hand fitting height								
Peinture comprise / inkl. Farbe / Paint included								
Epaisseur maximum du cadran Maximale Zifferblattstärke Maximum dial thickness								
No	Sous l'aiguille des secondes chrono Unter Stopp-Sekundenzeiger Under chrono second hand	Sous l'aiguille des minutes Unter Minutenzeiger Under minute hand	Sous l'aiguille des heures Unter Stundenzeiger Under hour hand	Compteur 2 aig. 2 Zeiger Zähler 2 Hand counter		Sous l'aiguille de petite seconde Unter kleine Sekundenzeiger Under small second hand	Epaisseur des aiguilles Zeigerdicke Hands thickness	
				minutes Unter minute hand	heures Unter hour hand			
2	2.10	1.55	1.10	0.70	0.40	0.40	0.15	
-								

	mg max.	µNm max.	gmm ² max.	N max.	Aig. des sec. chrono Stopp-Sekundenzeiger Chrono second hand	Aig. des minutes Minutenzeiger Minute hand	Aig. des heures Stundenzeiger Hour hand	Compteur 2 aiguille 2 Zeiger Zähler 2 Hand counter		Aig. petite secondes Kleine Sekundenzeiger Small second hand	Lors de la pose d'aiguilles, le mouvement doit être soutenu. Beim Zeigersetzen muss das Werk abgestützt werden. The movement needs to be supported for hand setting.
					minutes Unter minute hand	heures Unter hour hand	minutes Unter minute hand	heures Unter hour hand	petite secondes Unter kleine Sekundenzeiger		
Masse / Masse / Weight *	10	0.06	1.0	30	30	30	10	10	10	10	
Balourd / Unwucht / Unbalance *	30	0.80	-	40	40	40	0.03	0.03	0.03	0.07	
Inertie / Massenträgheit / Inertia *	-	-	1.0	-	-	-	1.0	-	-	0.4	
Force de chassage / Aufpresskraft / Force	30	40	40	30	30	30	30	30	30	30	

Aiguillages Zeigerwerkhöhe 12½" Hand fitting heights

	Issued	14 Nov 2003	mk
	Modified	15 Okt 2014 ÄA 13275	dh
	Released	Yes	
	Tolerance	µm	
	Scale	20 : 1 (A3H)	
Sous réserve de modifications Änderungen vorbehalten Modifications reserved			
RONDA	5020.B, 5130.D, 5130.B		
No.	3316.081	07	

* En cas de données différentes, veuillez contacter le service après-vente * Bei abweichenden Werten, bitte technischen Kundendienst anfragen * In case of different values, please contact the customer service

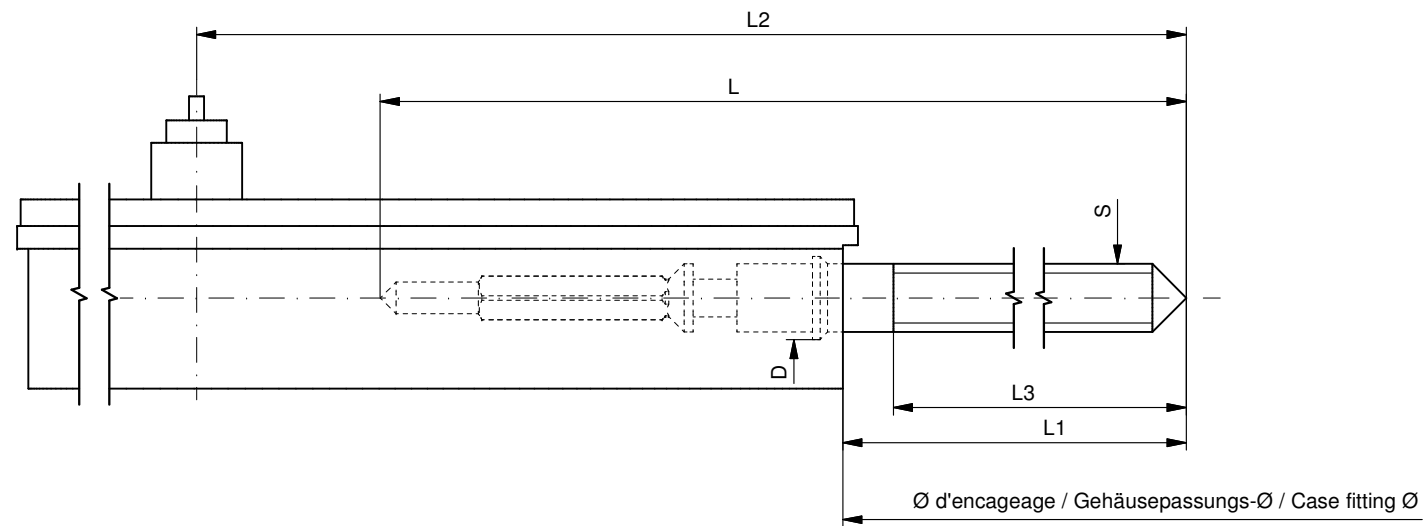

Tige de travail (intégrée dans le mouvement)
 Arbeitstellwelle (im Werk eingebaut)
 Working stem (implemented in the movement)

No. d'article Artikelnummer Part number	L	L1	L2	L3	S	D
3000.177.CO	20.00	10.23	24.23	10.15	0.90	1.10

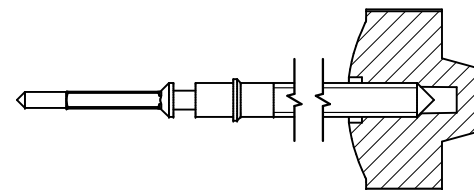

Couleur de la couronne Kronenfarbe Crown color	bleu foncé dunkelblau dark blue
Code	UN 5002

Tige (normale) / Stellwelle (normal) / Stem (normal)

No. d'article Artikelnummer Part number	L	L1	L2	L3	S	D
3000.177	20.00	10.23	24.23	10.15	0.90	1.10
3000.191	32.00	22.23	36.23	22.15	0.90	1.10

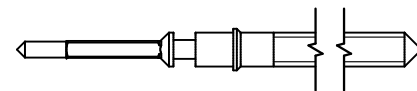

Couronne normale
 Normale Krone
 Normal crown

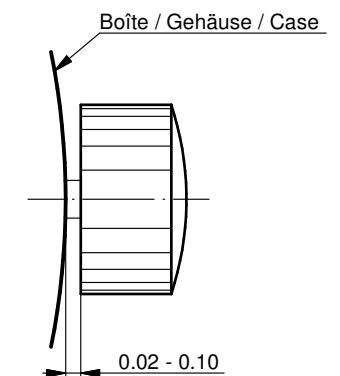

Couronne vissée
 Geschraubte Krone
 Screwed crown

Force ⇐ min. Kraft ⇐ min. Force ⇐ min.	10 N
Force ⇐ max. Kraft ⇐ max. Force ⇐ max.	15 N

Rallonge de tige / Stellwelle Verlängerung / Stem extension

No. d'article Artikelnummer Part number	L4	L5 (min)	L6	S1	S2	D1
3000.040	12.00	1.90	2.60	0.90	0.90	1.35

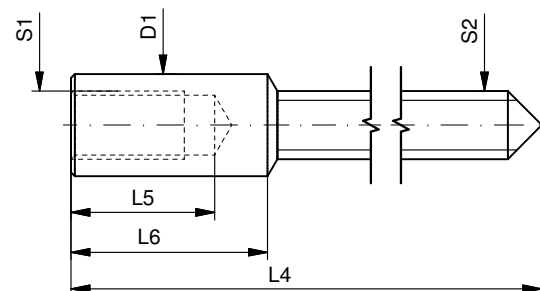

Tige (dimensions / forces)
 Stellwelle (Dimensionen / Kräfte)
 Stem (dimensions / forces)

RONDA

5010.B, 5020.B, 5021.D, 5030.D,
 5040.B, 5040.D, 5040.E, 5040.F,
 5050.B, 5050.C, 5051.C, 5130.B, 5130.D

Issued	05 Sep 2012	ds5222
Modified	17 Mär 2017 ÄA 34582	mg5224
Released	YES	
Tolerance	---	
Scale	10:1 (A3)	

Sous réserve de modifications
 Änderungen vorbehalten
 Modifications reserved

No.	5030.019	01
-----	----------	----



Movement holder
Removing setting stem
H5XXX.1T



Movement holder
Setting hands
H5XXX.1A

Fitting dial and hands

- Crown in position II
- Wind crown, until date 02 appears
- Crown in position III
- Wind hour hand forwards, until date changes to 03
- Remove working stem
- Fit dial
- Point all hands towards 12 o'clock
- Set time
- Zero chronograph hand*
- Crown in position II
- Set date
- Crown in position I

Date switching duration:

First and tenth digit discs

~2hrs

***Zeroing the Chronograph hand**

- Activate pushers A and B for 2 seconds at the same time
(Chrono seconds hand rotates once)
- Pusher A → to correct chrono seconds hand
- Pusher B → to make minute and seconds hand jump
- Pusher A → to correct hand position

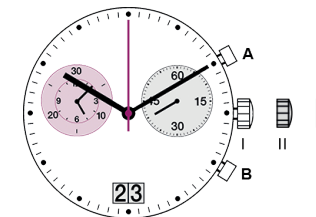
General Instructions

Removing the setting stem can only be effected in Pos. I.

The use of supporting screws is essential when mounting the hands.

Permitted hand setting strengths:

Hr / min. hands: <40N

Other hands: <30N

During quick date correction (setting stem in position II), a date switching speed of 5 d/s must not be exceeded.

You have decided to buy a watch, which was assembled by a watchmaker using a Ronda movement. Please note that no watches are produced or distributed under the Ronda Brand.

In case of repairs, guarantee claims and questions concerning the functioning of a watch, purchasers and consumers should contact their retailer or the watch manufacturer, for which the relevant information can be found in the sales or guarantee documentation provided with the watch.

Description of the display and control buttons

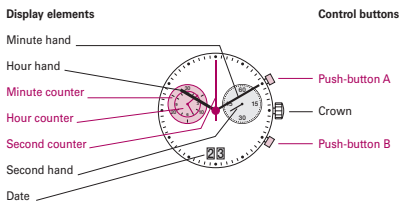

01

Setting the time

- 1 Pull out the crown to position III (the watch stops).
- 2 Turn the crown until you reach the correct time 8:45.
- 3 Push the crown back into position I.

Please note:
* In order to set the time to the exact second, 1 must be pulled out when the second hand is in position «60». Once the hour and minute hands have been set, 3 must be pushed back into position I at the exact second.

02

Setting the date (quick mode)

- 1 Pull out the crown to position II (the watch continues to run).
- 2 Turn the crown until the correct date 1 appears.
- 3 Push the crown back into position I.

Please note:
During the date changing phase between approx. 9 PM and midnight; the date must be set to the date of the following day.
An extreme acceleration in setting the date with quick mode can induce a false date indication. The synchronization is re-established by setting the date from 01 till 31 (crown in position II).

03

Setting the date/time

- 1 Pull out the crown to position II (the watch continues to run).
- 2 Turn the crown until yesterday's date appears 3.
- 3 Pull out the crown to position III (the watch stops).
- 4 Turn the crown until the correct date 4 appears.
- 5 Continue to turn the crown until the correct time 8:30 PM appears.
- 6 Push the crown back into position I.

Please note:
* To set your watch to the exact second, please refer to the chapter entitled «setting the time».
** Please observe the AM/PM clock rhythm.

04

Chronograph: Basic function

(Start / Stop / Reset)

Example:

- 1 Start: Press push-button A.
- 2 Stop: to stop the timing, press pushbutton A once more and read the chronograph counters: 4h / 20 min / 38 sec.
- 3 Zero positioning: Press push-button B. (The chronograph hands will be reset to their zero positions.)

05

Chronograph: Accumulated timing

Example:

- 1 Start: (start timing)
- 2 Stop: (e.g. 15 min 5 sec following 1)
- 3 Restart: (timing is resumed)
- 4 Stop: (e.g. 5 min 12 sec following 3) = 20 min 17 sec (The accumulated measured time is shown)
- 5 Reset: The chronograph hands are returned to their zero positions.

Please note:
* Following 4, the accumulation of the timing can be continued by pressing push-button A (Restart / Stop, Restart / Stop, ...).

06

Chronograph: Intermediate or interval timing

Example:

- 1 Start: (start timing)
- 2 Display interval: e.g. 20 minutes 17 seconds (timing continues in the background)
- 3 Making up the measured time: (The chronograph hands are quickly advanced to the ongoing measured time.)
- 4 Stop: (Final time is displayed)
- 5 Reset: The chronograph hands are returned to their zero position

Please note:
* Following 2, further intervals or intermediates can be displayed by pressing push-button B (display interval / make up measured time, ...).

07

Adjusting the chronograph hands to zero position

Example:

One or several chronograph hands are not in their correct zero positions and have to be adjusted (e.g. following a battery change).

- 1 Pull out the crown to position III (all chronograph hands are in their correct or incorrect zero position).
- 2 Keep push-buttons A and B depressed simultaneously for at least 2 seconds (the second counter hand rotates by 360° → corrective mode is activated).

Adjusting the second counter hand
Single step: A 1 x short
Continuous: A long

Adjusting the next hand B

Adjusting the minute counter hand and the hour counter hand (mechanical coupled)
Single step: A 1 x short
Continuous: A long

- 3 Returning the crown to position I
Termination of the chronograph hands adjustment (can be carried out at any time).



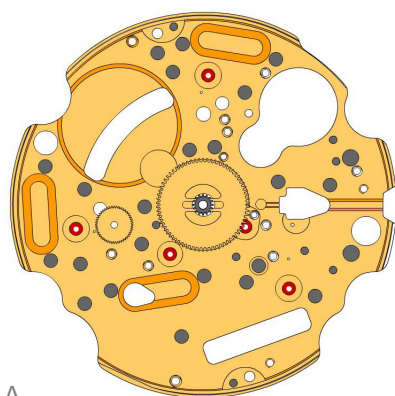



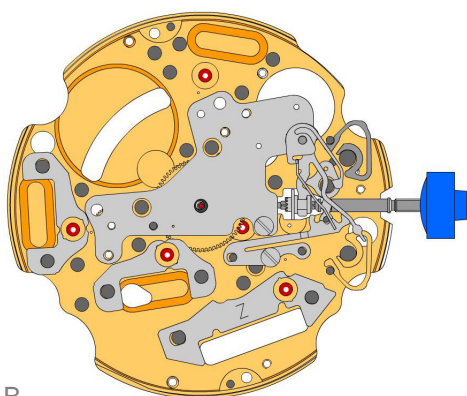









08









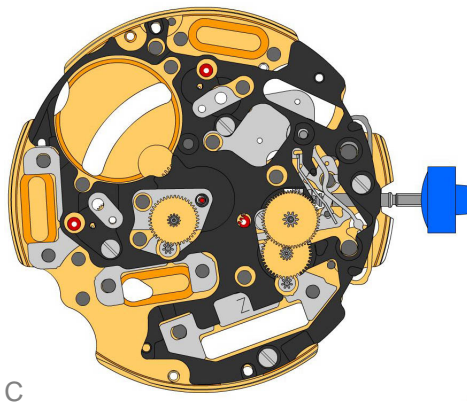

A





B

2000.574.G 1.		Main plate
3305.282.CO 2.		Cannon pinion with driver (Aig.2)
3301.244 3.		Hour wheel (counter 24h)
2030.017.CO 4.		Centre bridge Centre bridge held by 1 screw 4000.250. Parts 2030.017.CO, 3004.223 and 3500.059 must be exchanged together.
4000.250 5.		Screw
3001.055.FI 6.		Sliding pinion
3000.177.CO 7.		Setting stem
3017.049 8.		Setting lever
3905.049 9.		Setting lever jumper (3 positions) Setting lever jumper held by 1 screw 4000.250.
4000.250 10.		Screw
3015.081 11.		Yoke (3 positions) Parts 3015.081 and 3905.067 must be exchanged together.
3905.067 12.		Yoke spring Tensioning the spring arm. Parts 3015.081 and 3905.067 must be exchanged together.
3406.030 13.		Pusher jumper B Put the grey jumper between the two posts on the further side.
3406.038 14.		Pusher jumper A Put the yellow jumper between the two posts on the closer side.
3622.040 15.		Stator Mark Z on stator.
3622.039 16.		Stator (counter 6h, 9h, chrono)
3622.039 17.		Stator (counter 6h, 9h, chrono)



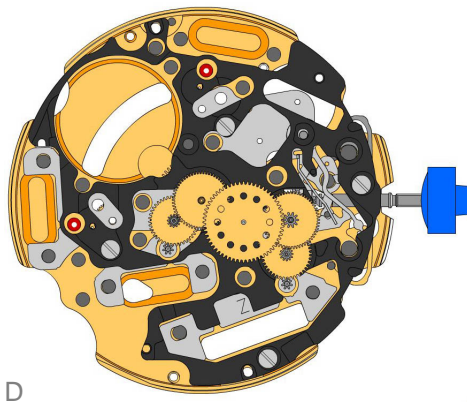



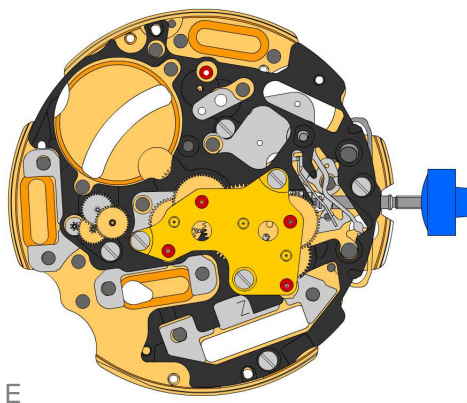

3603.079 18.		Plastic bracket Plastic bracket held by 4 screws 4000.250.
4000.250 19.		Screw
3715.094.RK 20.		Rotor
3715.094.RK 21.		Rotor
3147.046.CO 22.		Intermediate wheel
3136.142.CO 23.		Second wheel (long)
3147.047.CO 24.		Intermediate wheel (chrono)









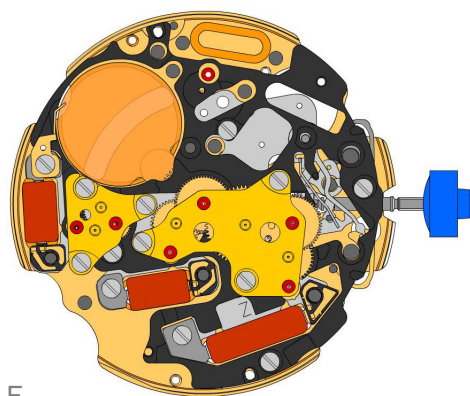
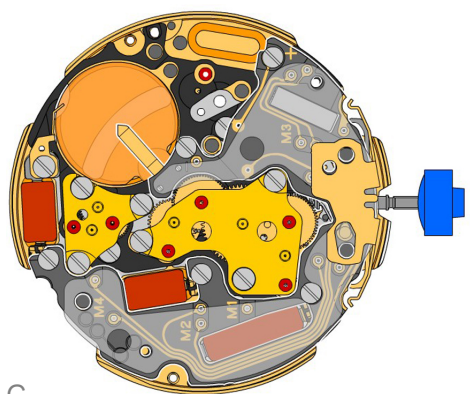
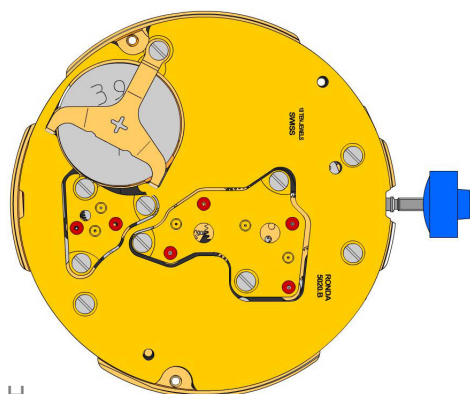









3136.144.CO 25.		Chronograph wheel (Aig.2)
3122.056.CO 26.		Third wheel







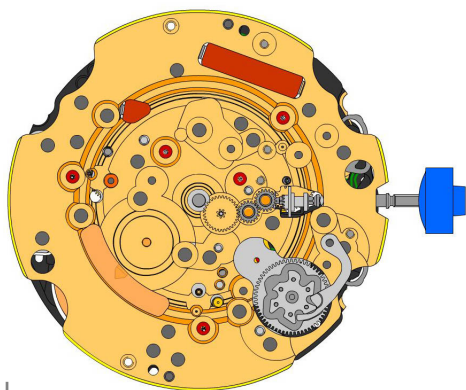

2020.148.G 27.		Train wheel bridge Train wheel bridge held by 3 screws 4000.250.
4000.250 28.		Screw
3715.095.RK 29.		Rotor
3147.048.CO 30.		Intermediate wheel (counter)
3007.056.CO 31.		Minute wheel (counter 24h)
3402.008.CO 32.		Minute counting wheel (24h)



F

G

H

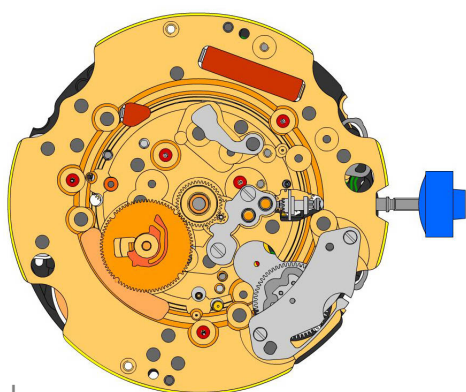





2020.149.G 33.		Counter train wheel bridge Counter train wheel bridge held by 3 screws 4000.250.
4000.250 34.		Screw
3621.053.RK 35.		Coil Attention: Please hold the coil only on the grey coil core. Coil held by 1 screw 4000.250.
3621.054.RK 36.		Coil (counter 9h, chrono) Attention: Please hold the coil only on the grey coil core. Coil held by 1 screw 4000.250.
3621.054.RK 37.		Coil (counter 9h, chrono) Attention: Please hold the coil only on the grey coil core. Coil held by 1 screw 4000.250.
3601.118 38.		Contact strip Contact strip held by 1 screw 4000.250.
4000.250 39.		Screw
3603.034 40.		Battery insulator
3503.054 41.		Tube
3612.144.5020 42.		Electronic module Electronic module tenue par 5 vis 4000.248. Electronic measurements may be realised now.
4000.248 43.		Screw
3603.069 44.		Circuit insulator
3601.107.G 45.		Pusher contact spring
2130.138.G.M01.5020B 46.		Electronic module cover Electronic module cover held by 3 screws 4000.250.
3600.010.HGF 47.		Battery 395
3601.109.G 48.		Bridle + Bridle held by 1 screw 4000.250.
4000.250 49.		Screw







2000.574.G 50.		Main plate
3004.164 51.		Setting wheel
3004.164 52.		Setting wheel
3007.054.CO 53.		Minute wheel
2130.143 54.		Minute train bridge Minute train bridge held by 1 screw 4000.305.
4000.305 55.		Screw



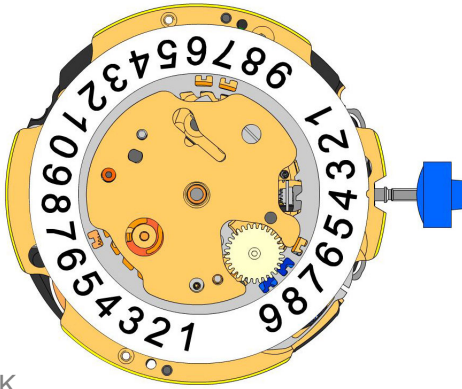





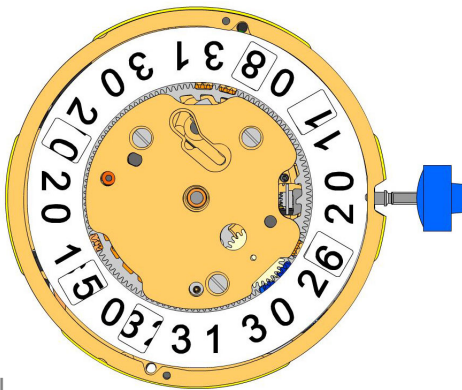

3004.223 56.		Tens indicator driving wheel Parts 2030.017.CO, 3004.223 and 3500.059 must be exchanged together. The short tooth of the tens indicator driving wheel must point to the center of the movement.
3500.059 57.		Tens jumper Parts 2030.017.CO, 3004.223 and 3500.059 must be exchanged together.

2130.142 58.		Tens jumper maintaining plate
4010.306 59.		Screw
3301.242 60.		Hour wheel (Fig.2)
3315.016 61.		Friction spring
3004.224.CO 62.		Date indicator driving wheel
3500.049 63.		Date jumper

K

3504.214.AD.1.A 64.		Units indicator (standard) Nick of the indicator at 3 o'clock.
3147.054 65.		Tens intermediate wheel
2130.141 66.		Date indicator maintaining plate Nick of the indicator at 3 o'clock.
3905.070 67.		Date jumper spring Insert the date jumper spring in the provided opening.

L

3504.215.AD.1.A 68.		Tens indicator (standard) Nick of the indicator at 3 o'clock.
2130.140.G 69.		Date mechanism maintaining plate Date mechanism maintaining plate held by 2 screws 4000.250.
4000.250 70.		Screw
3506.072.G 71.		Dial support
9014 72.		Moebius 9014
124 73.		Jismaa 124
9020 74.		Moebius 9020

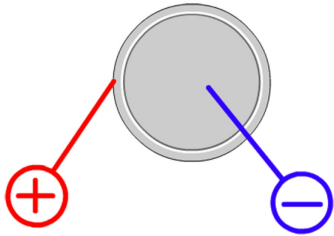

Battery	395
Voltage	1.55 V

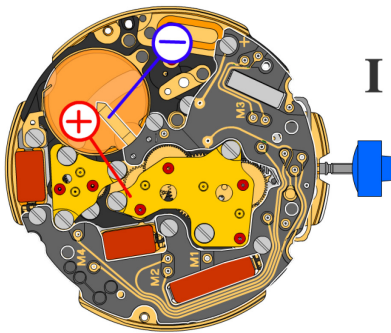

*Setting stem in position I, calendar not in gear,
60 s measuring interval for rate and consumption:*

Typical consumption	1.32 μA
Maximal consumption	1.65 μA
Rate	-10s/M. .. +20s/M.
Lower working voltage limit	1.20 V

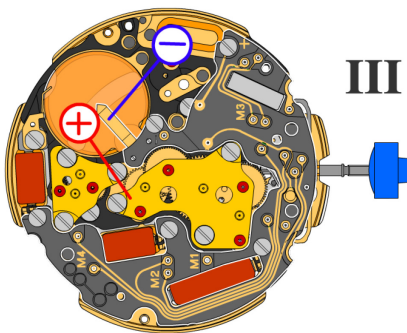

Setting stem in position III, 60 s measuring interval:

Typical consumption	0.10 μA
Maximal consumption	0.30 μA

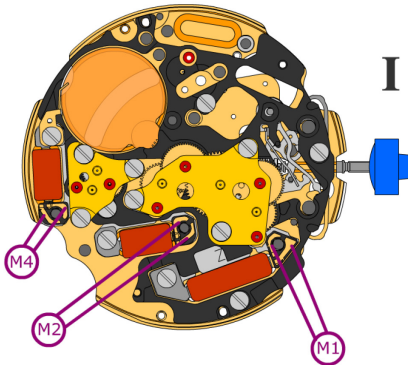

Coil resistance M1 **1.90 k Ω .. 2.10 k Ω**

Coil resistance M2 **1.68 k Ω .. 1.88 k Ω**

Coil resistance M4 **1.68 k Ω .. 1.88 k Ω**

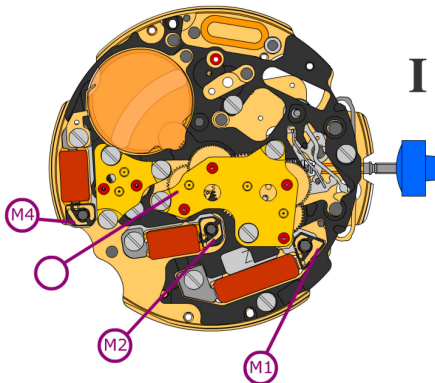

Coil isolation M1/M2/M4 **∞ k Ω**

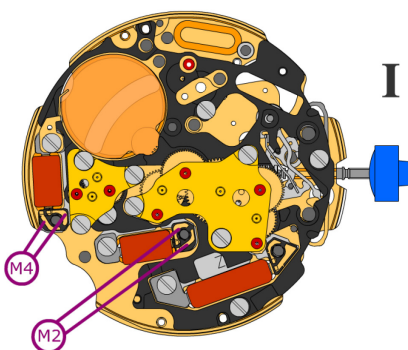

Signal generator (4.9 ms, 8 Hz):



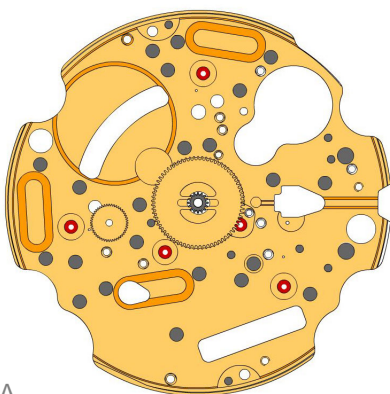

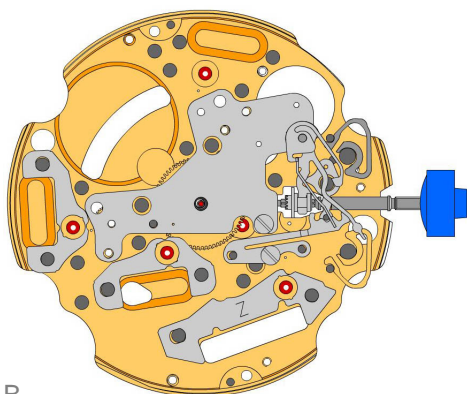

Lower working voltage limit M2/M4 **1.20 V**





A

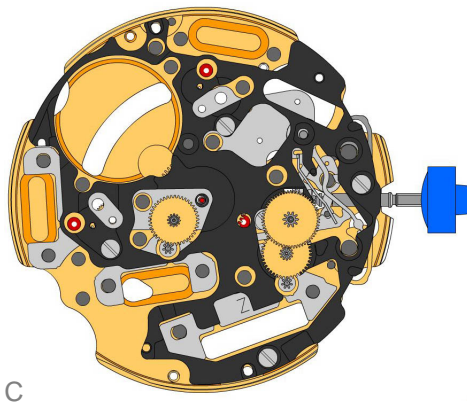

B

2000.574.G 1.		Main plate
3305.282.CO 2.		Cannon pinion with driver (Aig.2)
3301.244 3.		Hour wheel (counter 24h)
2030.024.CO 4.		Centre bridge Centre bridge held by 1 screw 4000.250.
4000.250 5.		Screw
3001.055.FI 6.		Sliding pinion
3000.177.CO 7.		Setting stem
3017.049 8.		Setting lever
3905.049 9.		Setting lever jumper (3 positions) Setting lever jumper held by 1 screw 4000.250.
4000.250 10.		Screw
3015.081 11.		Yoke (3 positions)
3905.067 12.		Yoke spring Tensioning the spring arm.
3406.030 13.		Pusher jumper B Put the grey jumper between the two posts on the further side.
3406.038 14.		Pusher jumper A Put the yellow jumper between the two posts on the closer side.
3622.040 15.		Stator Mark [Z] on stator.
3622.039 16.		Stator (counter 6h, 9h, chrono)
3622.039 17.		Stator (counter 6h, 9h, chrono)

C

3603.079
18.  **Plastic bracket**
Plastic bracket held by 4 screws 4000.250.

4000.250
19.  **Screw**

3715.094.RK
20.  **Rotor**

3715.094.RK
21.  **Rotor**

3147.046.CO
22.  **Intermediate wheel**

3136.142.CO
23.  **Second wheel (long)**

3147.047.CO
24.  **Intermediate wheel (chrono)**

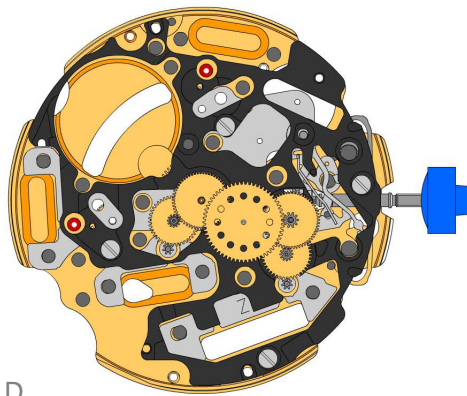
D

3136.144.CO
25.  **Chronograph wheel (Aig.2)**

3122.056.CO
26.  **Third wheel**

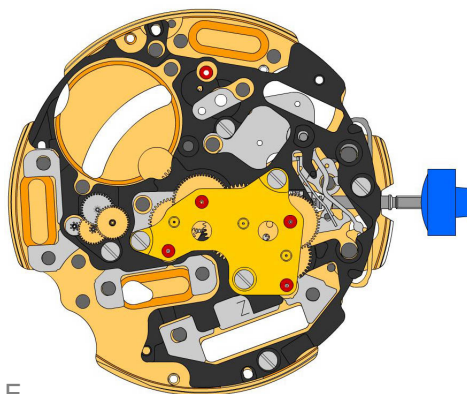
E

2020.148.G
27.  **Train wheel bridge**
Train wheel bridge held by 3 screws 4000.250.

4000.250
28.  **Screw**









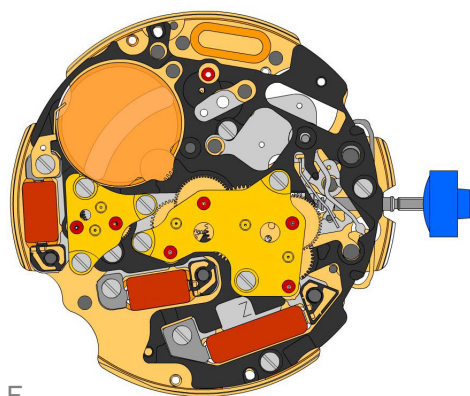
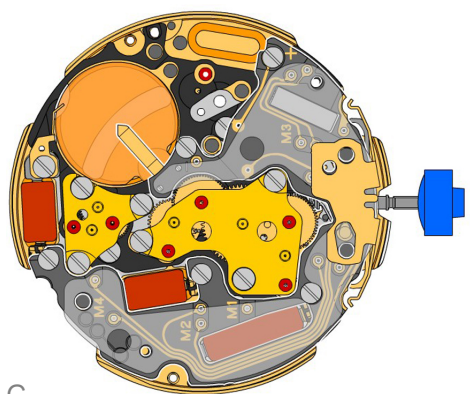
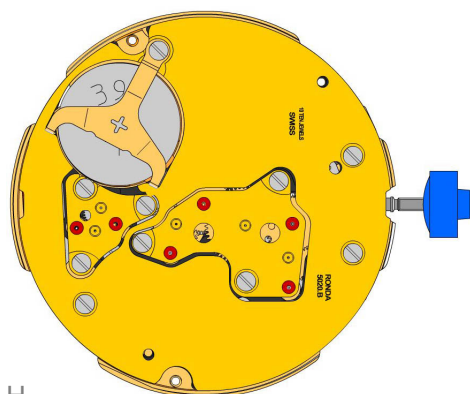







3715.095.RK
29.  **Rotor**

3147.048.CO
30.  **Intermediate wheel (counter)**









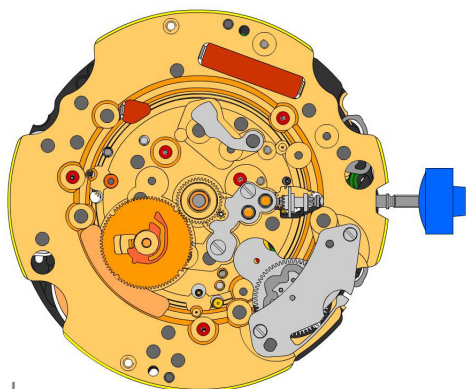
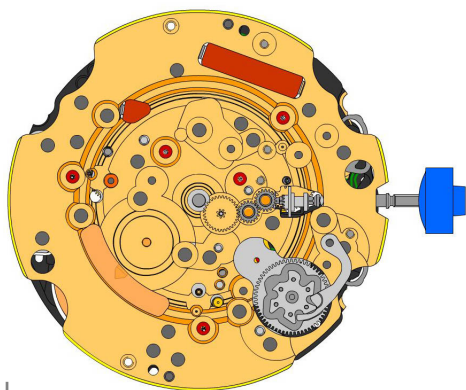





3007.056.CO
31.  **Minute wheel (counter 24h)**

3402.008.CO
32.  **Minute counting wheel (24h)**





F

G

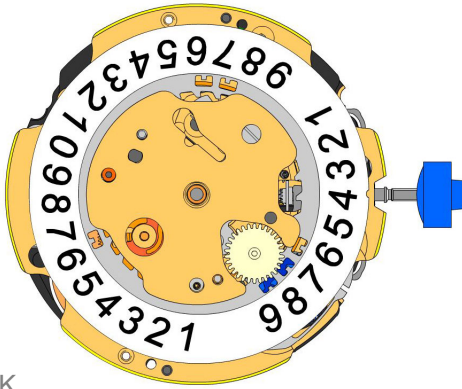
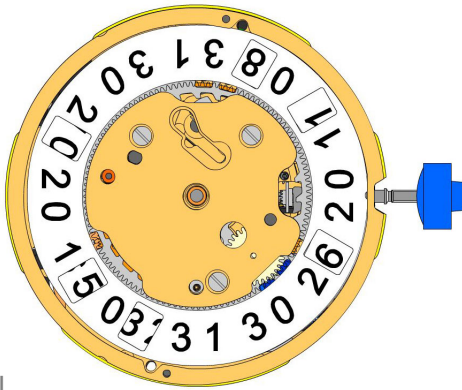
H





2020.149.G 33.		Counter train wheel bridge Counter train wheel bridge held by 3 screws 4000.250.
4000.250 34.		Screw
3621.053.RK 35.		Coil Attention: Please hold the coil only on the grey coil core. Coil held by 1 screw 4000.250.
3621.054.RK 36.		Coil (counter 9h, chrono) Attention: Please hold the coil only on the grey coil core. Coil held by 1 screw 4000.250.
3621.054.RK 37.		Coil (counter 9h, chrono) Attention: Please hold the coil only on the grey coil core. Coil held by 1 screw 4000.250.
3601.118 38.		Contact strip Contact strip held by 1 screw 4000.250.
4000.250 39.		Screw
3603.034 40.		Battery insulator
3503.054 41.		Tube
3612.144.5020 42.		Electronic module Electronic module tenue par 5 vis 4000.248. Electronic measurements may be realised now.
4000.248 43.		Screw
3603.069 44.		Circuit insulator
3601.107.G 45.		Pusher contact spring
2130.138.G.M01.5020B 46.		Electronic module cover Electronic module cover held by 3 screws 4000.250.
3600.010.HGF 47.		Battery 395
3601.109.G 48.		Bridle + Bridle held by 1 screw 4000.250.
4000.250 49.		Screw







2000.574.G 50.		Main plate
3004.164 51.		Setting wheel
3004.164 52.		Setting wheel
3007.054.CO 53.		Minute wheel
2130.143 54.		Minute train bridge Minute train bridge held by 1 screw 4000.305.
4000.305 55.		Screw
3004.227 56.		Tens indicator driving wheel The short tooth of the tens indicator driving wheel must point to the center of the movement.
3500.075 57.		Tens jumper
2130.142 58.		Tens jumper maintaining plate
4010.306 59.		Screw
3301.242 60.		Hour wheel (Fig.2)
3315.016 61.		Friction spring
3004.224.CO 62.		Date indicator driving wheel
3500.049 63.		Date jumper

K

L

3504.214.AD.1.A 64.		Units indicator (standard) Nick of the indicator at 3 o'clock.
3147.054 65.		Tens intermediate wheel
2130.141 66.		Date indicator maintaining plate Nick of the indicator at 3 o'clock.
3905.070 67.		Date jumper spring Insert the date jumper spring in the provided opening.

3504.215.AD.1.A 68.		Tens indicator (standard) Nick of the indicator at 3 o'clock.
2130.140.G 69.		Date mechanism maintaining plate Date mechanism maintaining plate held by 2 screws 4000.250.
4000.250 70.		Screw
3506.072.G 71.		Dial support

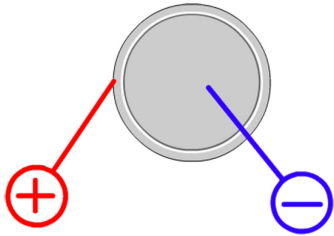
8200 72.		Moebius 8200
9014 73.		Moebius 9014
124 74.		Jismaa 124
9020 75.		Moebius 9020



Battery	395
Voltage	1.55 V

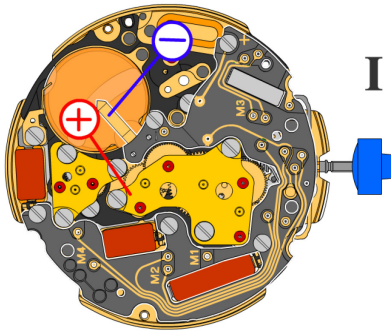

*Setting stem in position I, calendar not in gear,
60 s measuring interval for rate and consumption:*

Typical consumption	1.32 μA
Maximal consumption	1.65 μA
Rate	-10s/M. .. +20s/M.
Lower working voltage limit	1.20 V

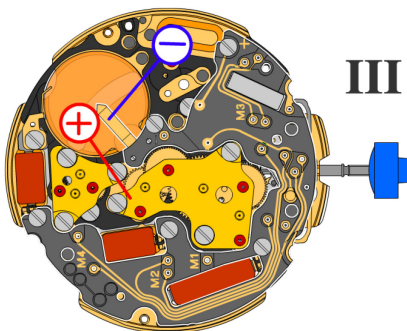

Setting stem in position III, 60 s measuring interval:

Typical consumption	0.10 μA
Maximal consumption	0.30 μA

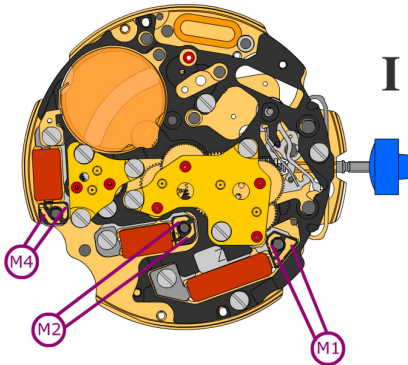

Coil resistance M1 **1.90 k Ω .. 2.10 k Ω**

Coil resistance M2 **1.68 k Ω .. 1.88 k Ω**

Coil resistance M4 **1.68 k Ω .. 1.88 k Ω**

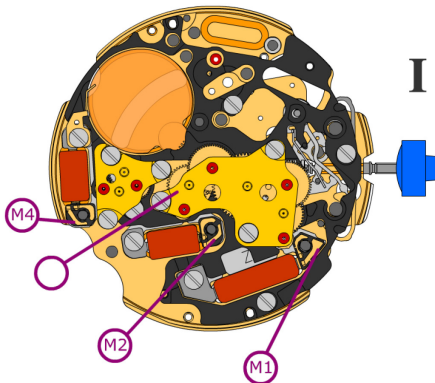

Coil isolation M1/M2/M4 **∞ k Ω**

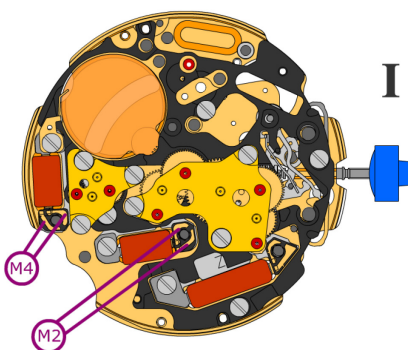

Signal generator (4.9 ms, 8 Hz):

Lower working voltage limit M2/M4 **1.20 V**